

Canal equipado

Canales equipados

Código: 3026 880



DETALLES

Borde Instalación Bajo la encimera

Material Acero inoxidable AISI 304

Acabado Foster cepillado

Texture Cepillado en la línea

Base 120 cm

Dimensiones externas 1138 x 170 mm

Dimensiones internas 1122 x 122 mm

Anchura 113,8 cm

Longitud 8 unidad - Standard

Hueco de encastre

Ver hoja de datos técnicos

Dotaciones estándar

Soportes de fijación, desagüe, caja de embalaje

Desagüe

Desagüe 1¼"

Clave de lectura para los accesorios.

Las longitudes de los canales y accesorios se indican en "unidades", para la composición la suma de las "unidades" de los accesorios debe corresponder a la longitud en "unidades" del canal.

DIBUJOS TÉCNICOS

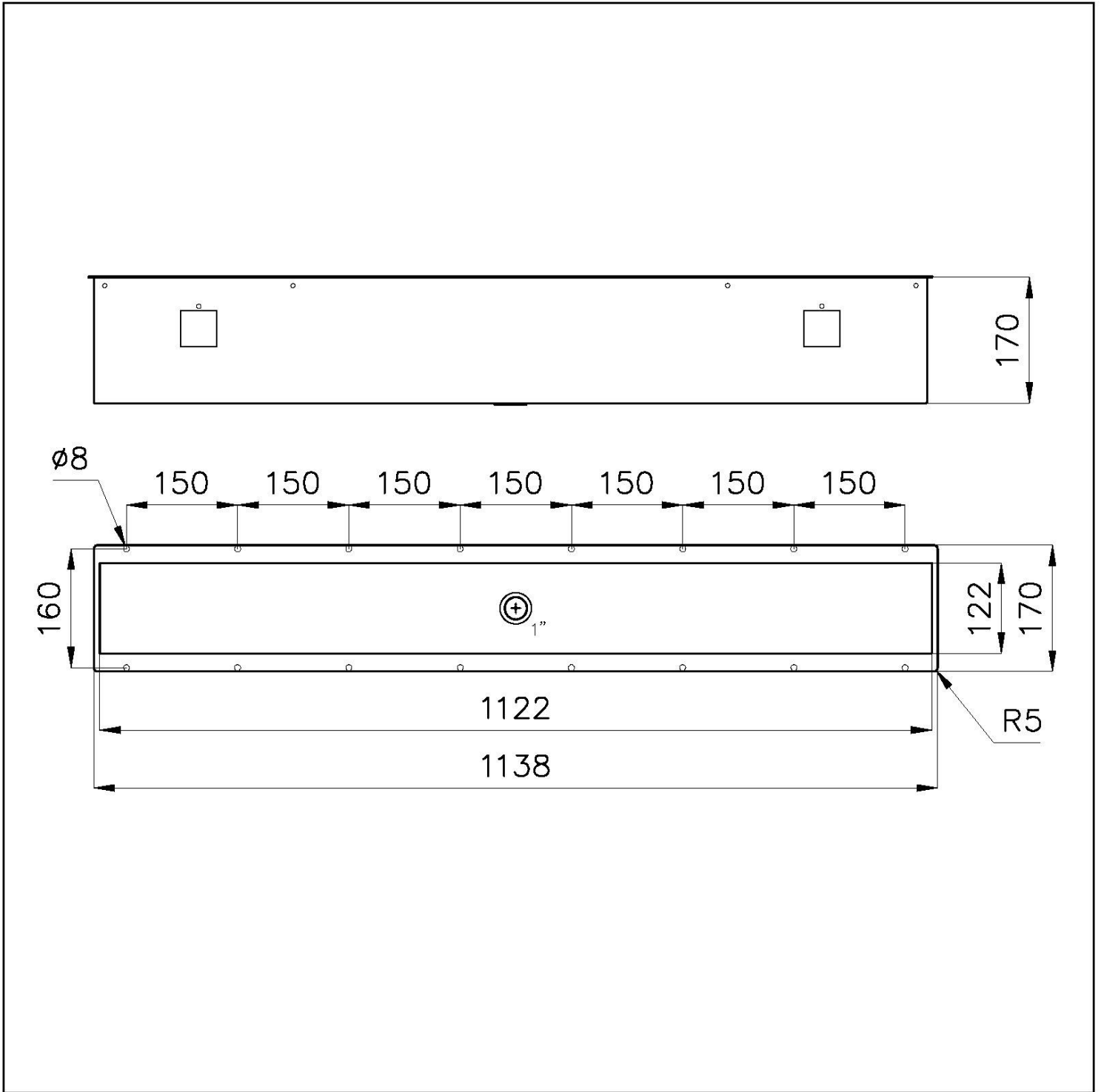

Sottotop/Undermount

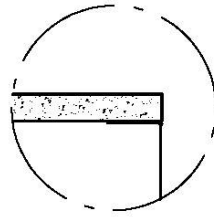

B-B:
Dettaglio installazione
Installation detail

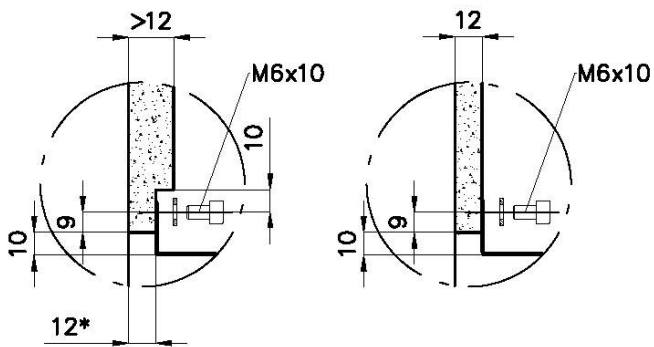

A-A:
Dettaglio installazione positive reveal e sistema di fissaggio
Installation detail with positive reveal and fixing system

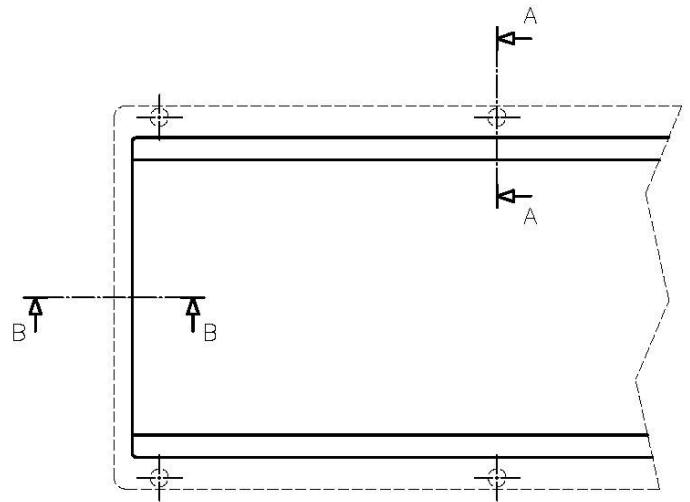

*spessore consigliato per un abbinamento perfetto con gli accessori
*recommended thickness for a perfect match with the accessories

Dimensioni per foratura top
Cut out size

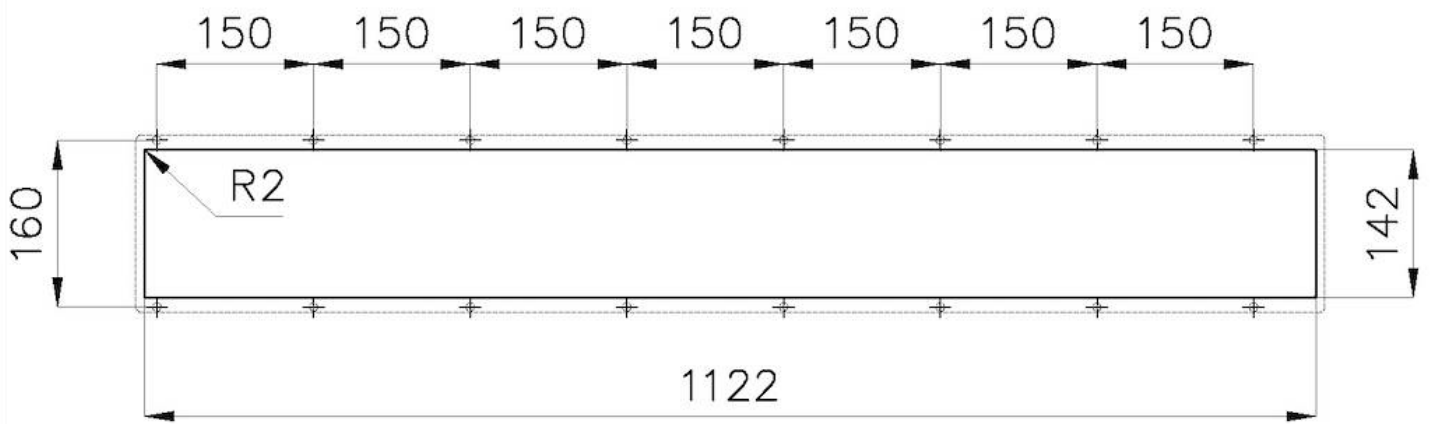

GALERÍA



ACCESORIOS OPCIONALES



Bandeja perforada inox
8151 003



Kit "A"
8100 703



Kit "B"
8100 700



Kit "C"
8100 701



Kit "D"
8100 704



Kit "E"
8100 705



Kit "F"
8100 706



Kit "G"
8100 710



Kit "H"
8100 702



Kit "N"
8100 714



Portaplatos inox
1773 100



Stainless steel knife holder
8100 712



**Tomas múltiples de acero
inoxidable**
8000 020